

Coaxial RF Termination

TRF5005241



DC-50 GHz, 2.4mm Female, 5 Watts

Electrical

Impedance	50 ohm
Frequency Range	DC-50 GHz
VSWR	1.3 max
Input Avg Power	5W@25°C ambient, derating linearly to 0.5W at 100°C
Peak Power	100W (5 micro-sec pulse width, 2% duty cycle)

Mechanical

Connector Body	Passivated stainless steel
Center Contact	1.27um gold plated BeCu
Heat Sink	Black anodized aluminum

Environmental

Operating Temp	-55°C to 100°C
Storage Temp	-55°C to 125°C
RoHS	Compliant

Dimensions(mm)

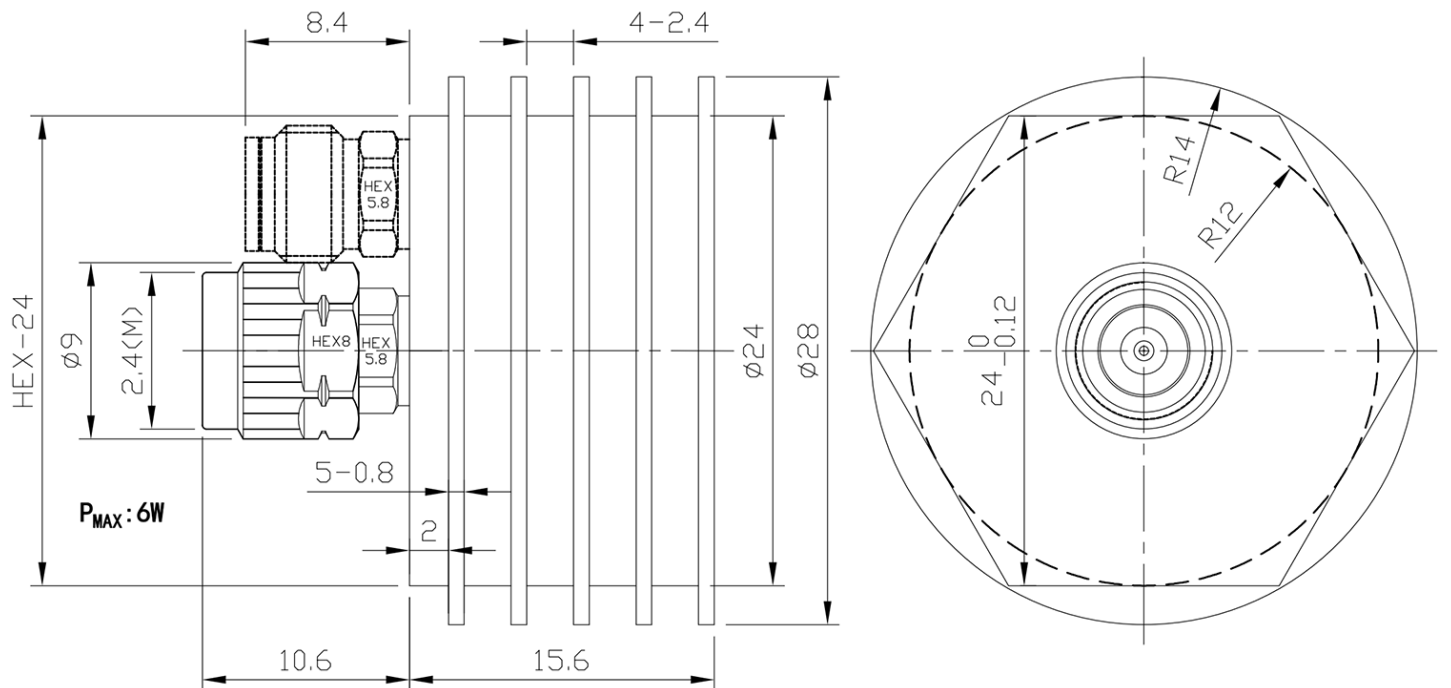

Typical Test Data

