

## 2.4mm Female to 2.4mm Female 4 Hole Flange Adapter

### Drawing(mm)

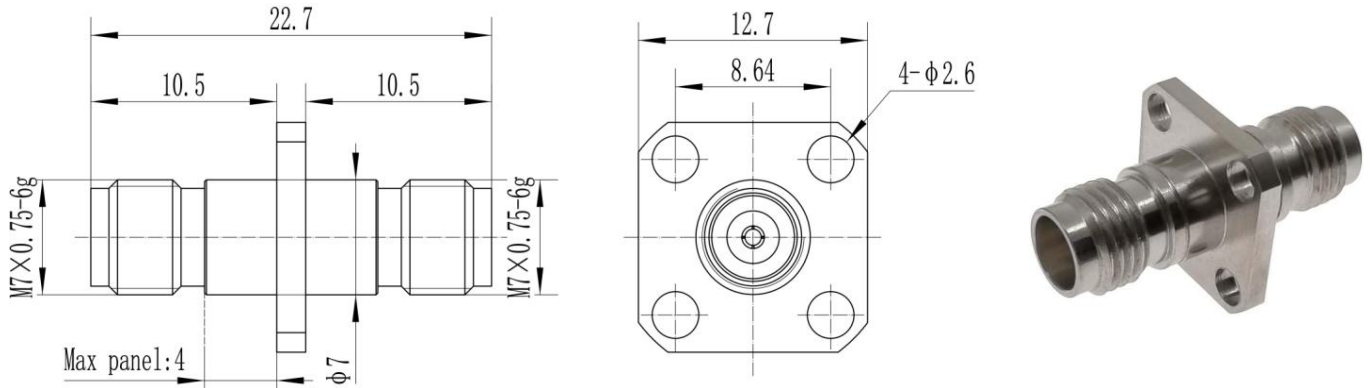

### Electrical & Environmental

<b>Impedance</b>	50 ohm
<b>Frequency Range</b>	50 GHz
<b>VSWR</b>	1.2 max
<b>Operating Temp</b>	-55°C to +165°C
<b>Interface</b>	2.4mm per IEC 61169

### Material

<b>Connector Body</b>	Passivated stainless steel
<b>Center Contact</b>	Gold plated beryllium copper
<b>Insulator</b>	PEI