

SRFS TELEINFRA

Get connected with us:



2.92mm Male to Female Fixed attenuator, DC-40GHz,30dB,20W

Model no.: SRFS-AT-2.92MF-30-20



Electrical Specifications	
Impedance	50 ohm
Frequency Range	DC-40 GHz
VSWR	1.26max
Input Avg Power	20W@ 25°C
Peak Power	200W
Direction	Unidirectional, 2.92mm male input, 2.92mm female output
Attenuation(dB)	30
Accuracy(dB)	-1.0/+1.0
Mechanical Specifications	
Connector Body	Passivated stainless steel
Heat Sink	Black anodized aluminum
Center Contact	1.27um Gold plated BeCu
Operating Temperature	-55°C to 100°C
Storage Temperature	-55°C to 125°C
RoHS	Compliant

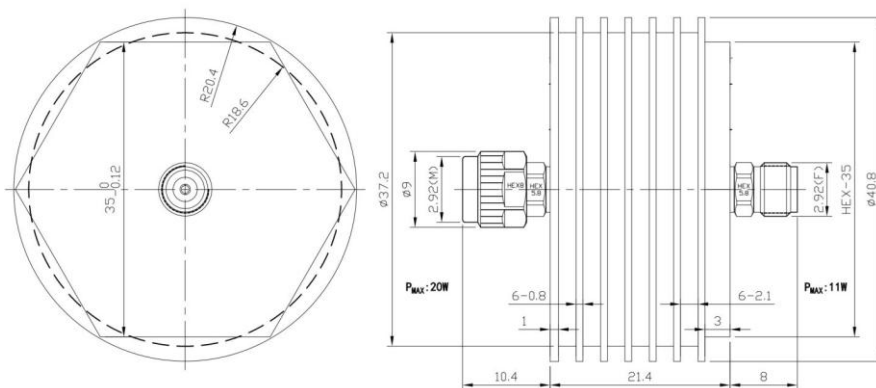

Add: plot no 10 shiv Vihar a block Najafgarh Sahibi river road Vikas Nagar Uttam Nagar new delhi-110059

+91-9027232570, +91-8800726650, +91 8076749052 info@srfsteleinfra.in, info@srfsteleinfra.com, srfsteleinfra@gmail.com

www.srfsteleinfra.in, www.srfsteleinfra.com

SRFS Teleinfra | All specifications are subject to change.
SRFS reserves the right to make such changes as required. Unless otherwise stated, all specifications are nominal.
It may be necessary to make modifications to the part and/or the documentation of the part to implement improvements.
See www.srfsteleinfra.in for the most current information. Revised: 19 Jan 2023



SRFS TELEINFRA

Get connected with us:



2.92mm Male to Female Fixed attenuator, DC-40GHz,30dB,20W

Model no.: SRFS-AT-2.92MF-30-20

Test Result:

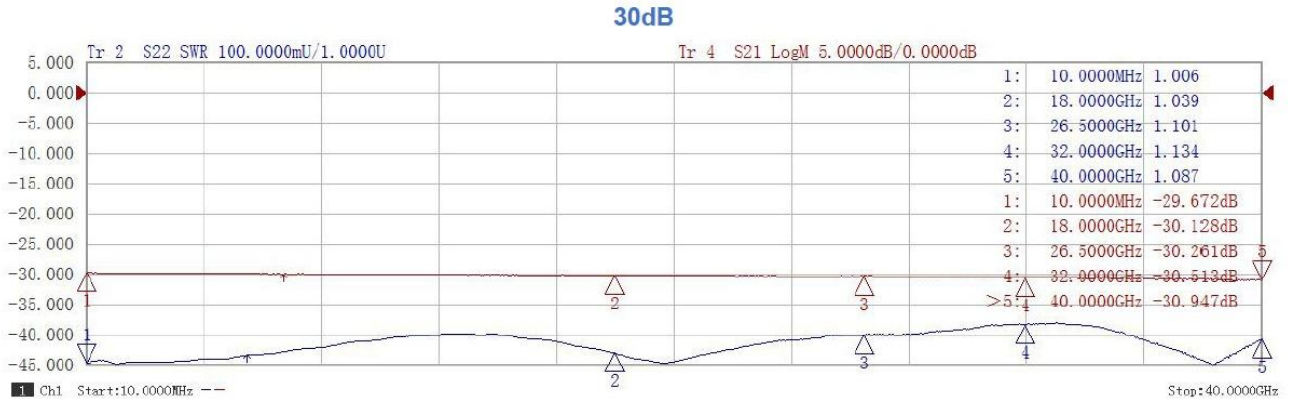

Add: plot no 10 shiv Vihar a block Najafgarh Sahibi river road Vikas Nagar Uttam Nagar new delhi-110059
+91-9027232570, +91-8800726650, +91 8076749052 info@srfsteleinfra.in, info@srfsteleinfra.com, srfsteleinfra@gmail.com
www.srfsteleinfra.in, www.srfsteleinfra.com

SRFS Teleinfra | All specifications are subject to change.
SRFS reserves the right to make such changes as required. Unless otherwise stated, all specifications are nominal.
It may be necessary to make modifications to the part and/or the documentation of the part to implement improvements.
See www.srfsteleinfra.in for the most current information. Revised: 19 Jan 2023

