

SRFS TELEINFRA

Get connected with us:



698-4000 MHz N Female 10dB Directional Coupler (Model No. SRFS-DC-10-5G)



Electrical and Mechanical Specifications	
Operating Frequency	698-4000 MHz
Impedance	50 Ohm
VSWR	1.25
Coupling	10 dB
Tolerance	1.0 dB
Insertion Loss	0.96 dB
Isolation	≥28 dB
IM3 (dBc @ 2 × 43dBm)	-150 dBc
Application	Indoor/Outdoor
Operating Temperature	-40 to 80 °C
Interface	N Female /Din Female /4.3-10 Female
Handling Power	300 W
Peak Power	1200 W
Dimension (mm) (L × W × H, excl connector)	110*36*18 mm
Net Weight	155±20 Gms
ROHS Compliance	Yes

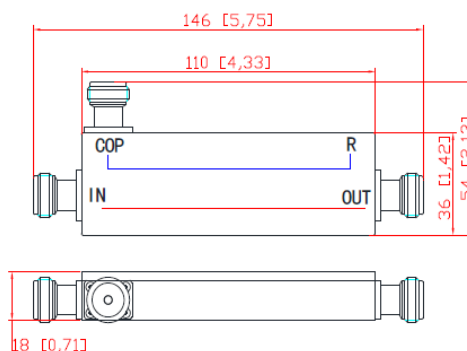

Add: plot no 10 shiv vihar a block Najafgarh Sahibi river road Vikasnagar Uttam nagar new delhi-110059

+91-9027232570, +91-8800726650, +91 8076749052 info@srfsteleinfra.in, info@srfsteleinfra.com, srfsteleinfra@gmail.com

www.srfsteleinfra.in, www.srfsteleinfra.com

SRFS Teleinfra | All specifications are subject to change.
SRFS reserves the right to make such changes as required. Unless otherwise stated, all specifications are nominal.
It may be necessary to make modifications to the part and/or the documentation of the part to implement improvements.
See www.srfsteleinfra.in for the most current information. Revised: 19 Jan 2023

