

## WR12 Waveguide to Coaxial Adapter Right Angle Part no. SRFS740WCA1.0KPC

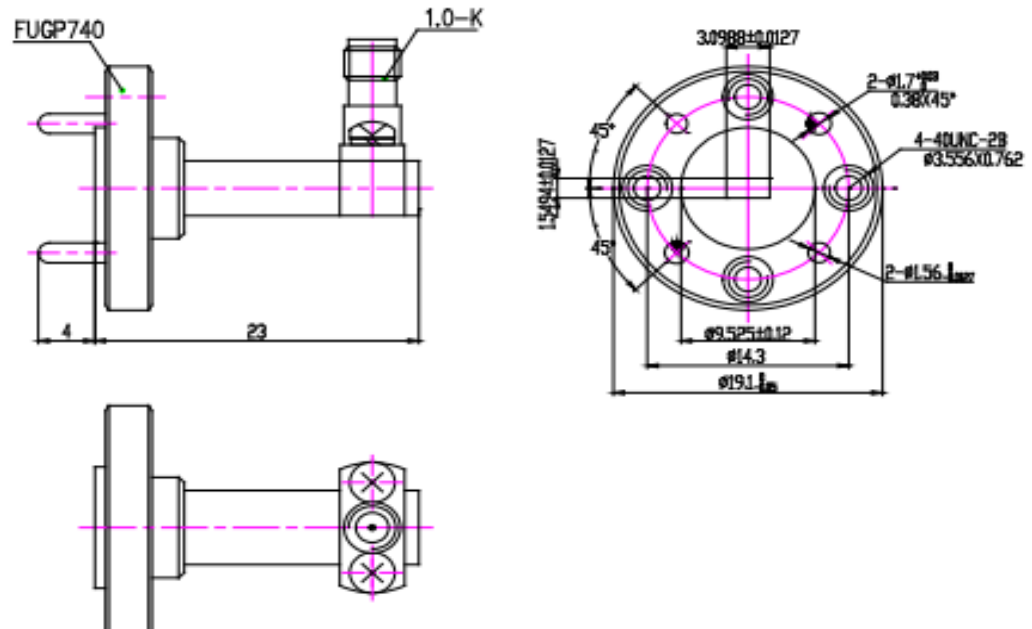

Mechanical Specifications	
Waveguide Type	WR12
Connector type	1.0 Female
Material	Copper
Finish	Gold plating
Flange Type	FUGP740
Temp range	-30°C to +70°C
Electrical Specifications	
Frequency Range	60-90 GHz
VSWR (Max)	1.6
Insertion loss	1 dB