

Standard Gain Horn Antenna SRFS3SGAH10NK

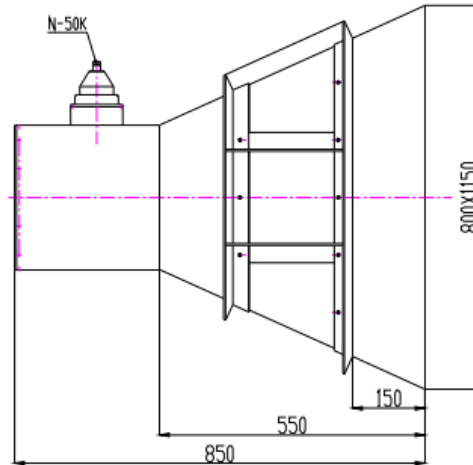

Mechanical Specifications	
Waveguide type	WR2300
Material	Aluminum
Connector Type	N Female
Inside finish	Chromate conversion
Outside finish	Anticorrosion grey paint
Electrical Specifications	
Frequency Range	0.32-0.49 GHz
VSWR (Max)	1.5
Gain(Avg)	10dB