

10 dB Directional Coupler

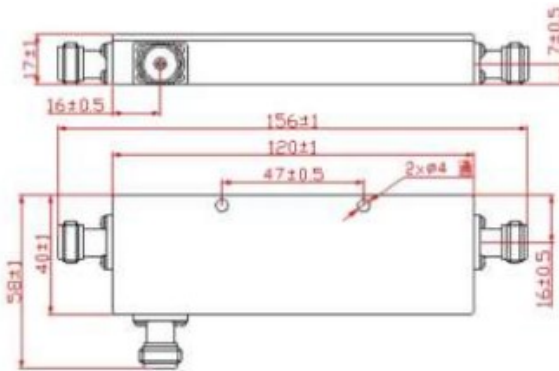

ELECTRICAL&MECHANICAL SPECIFICATIONS	
Frequency Band (MHz)	698-2700MHz
Coupling(dB)	7 dB
Ripple in Band(dB)	±0.8
Insertion Loss(dB)	≤0.9
VSWR	≤1.25:1
Directionality(dB)	≥18
3rd order IMD	≤-140/-155@+43dBm×2
Power Capacity	300W(Average)
Impedance	50ohm
RF Connector	N-Female
Temperature(°C)	-35~+65
Relative Humidity	5%~95%
Application Indoor & Outdoor	IP65
Color	Black or Customized
Weight(kg)	0.225KG